



中山市川狼五金制品厂

ZHONG SHAN CHUAN LANG LIGHTING CO., LTD

型号: 野狼101-100W-T70*140

外观图



线条图

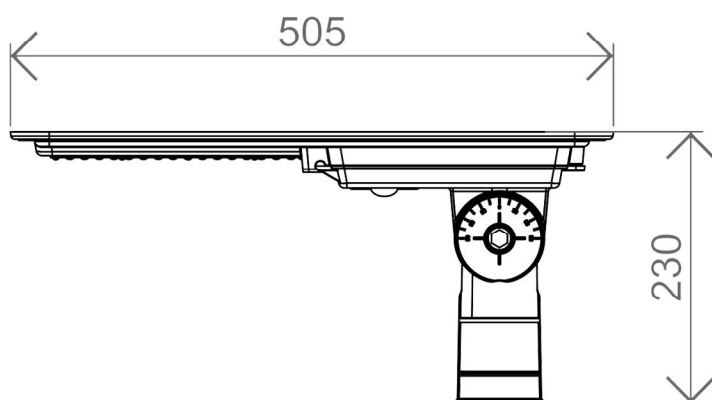

主视图

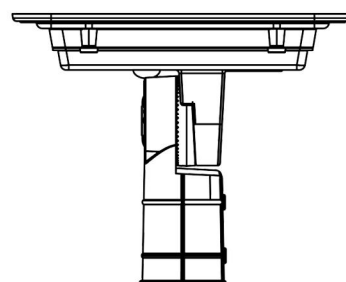

左视图

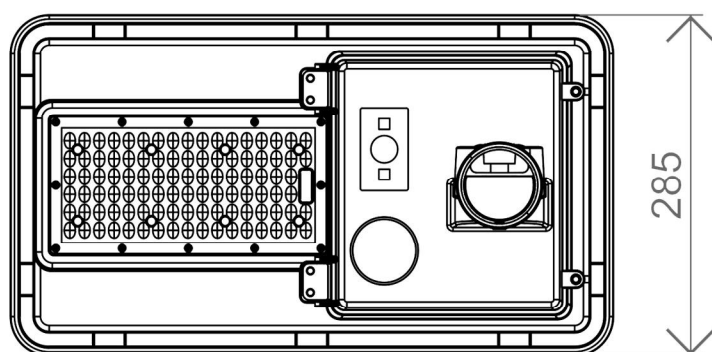

俯视图

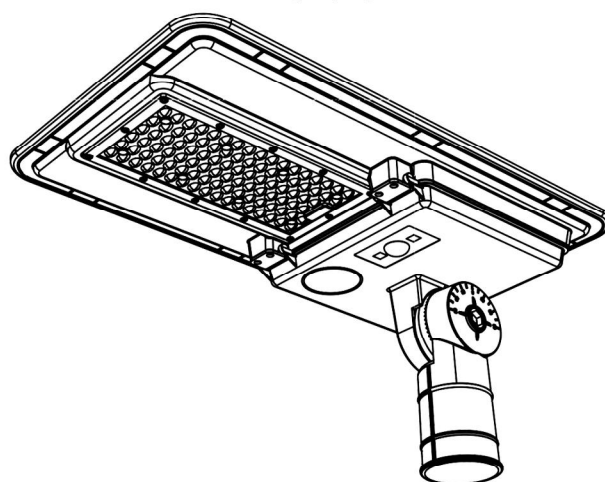

透视图

外形尺寸: 505*285*H230

铝基板-透镜

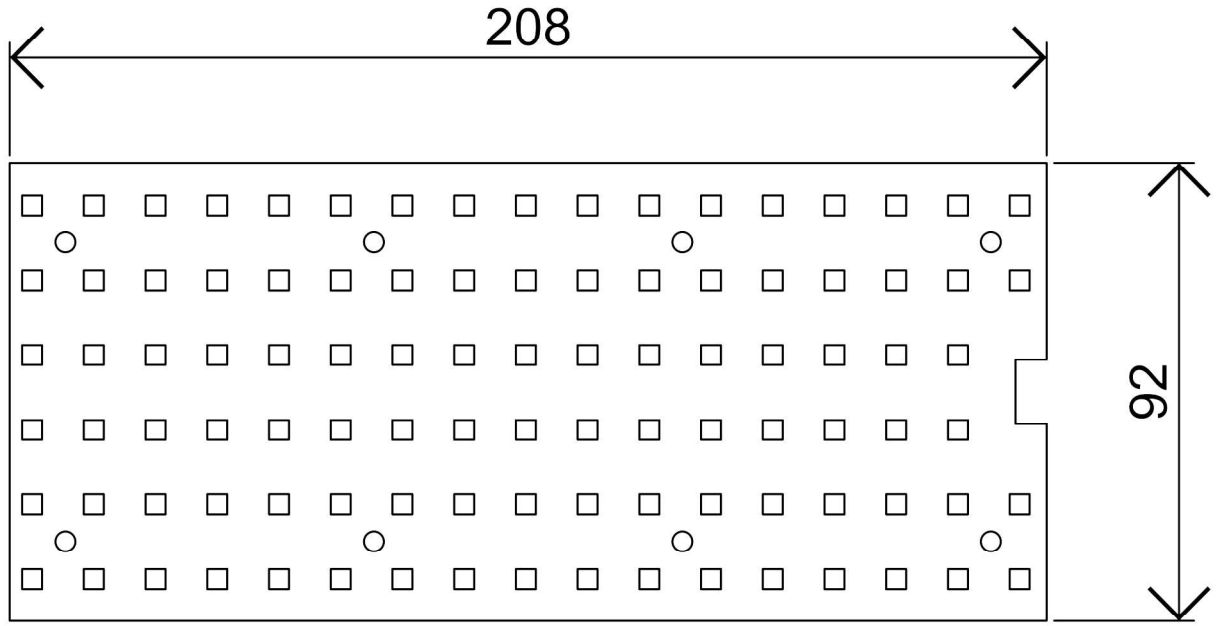

铝基板:92mm*208*T1.2mm

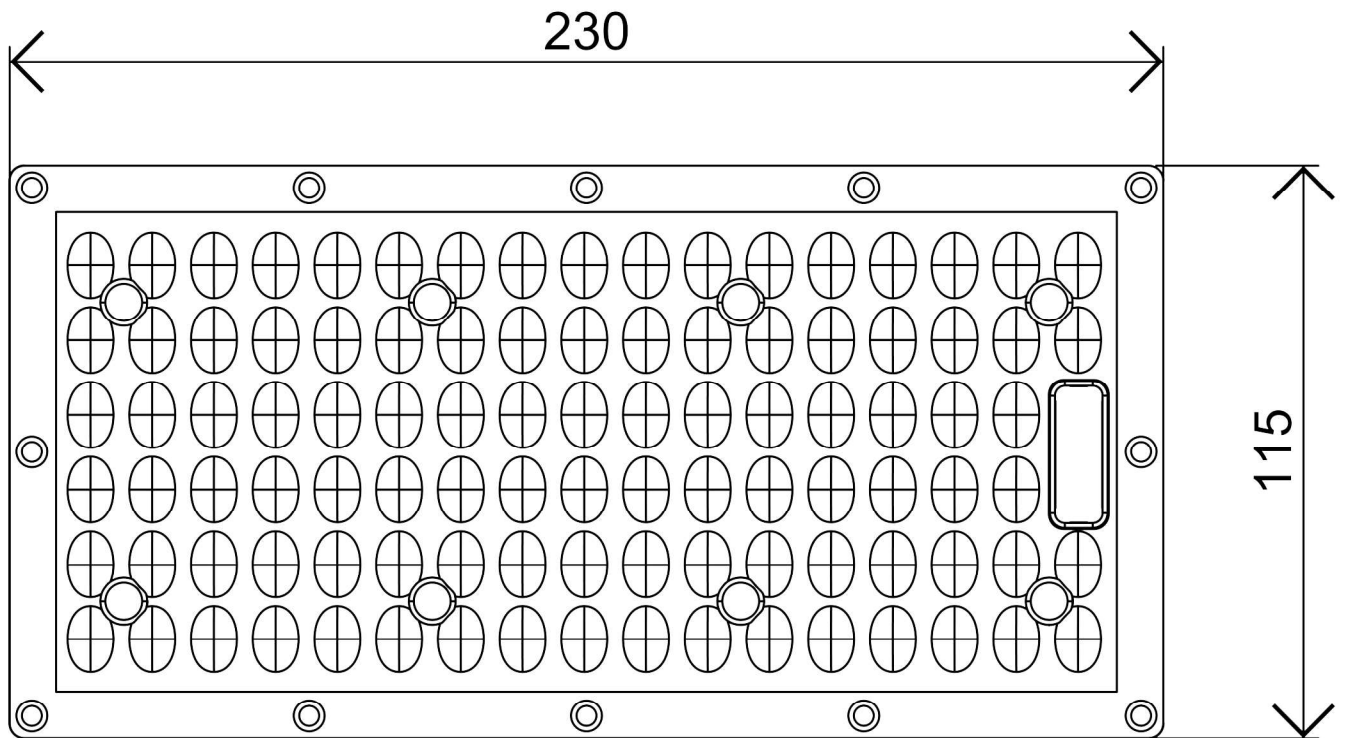

透镜:115*230*H8*T8.5mm

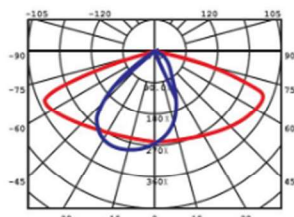

光束角70度-140度

灯体尺寸孔位

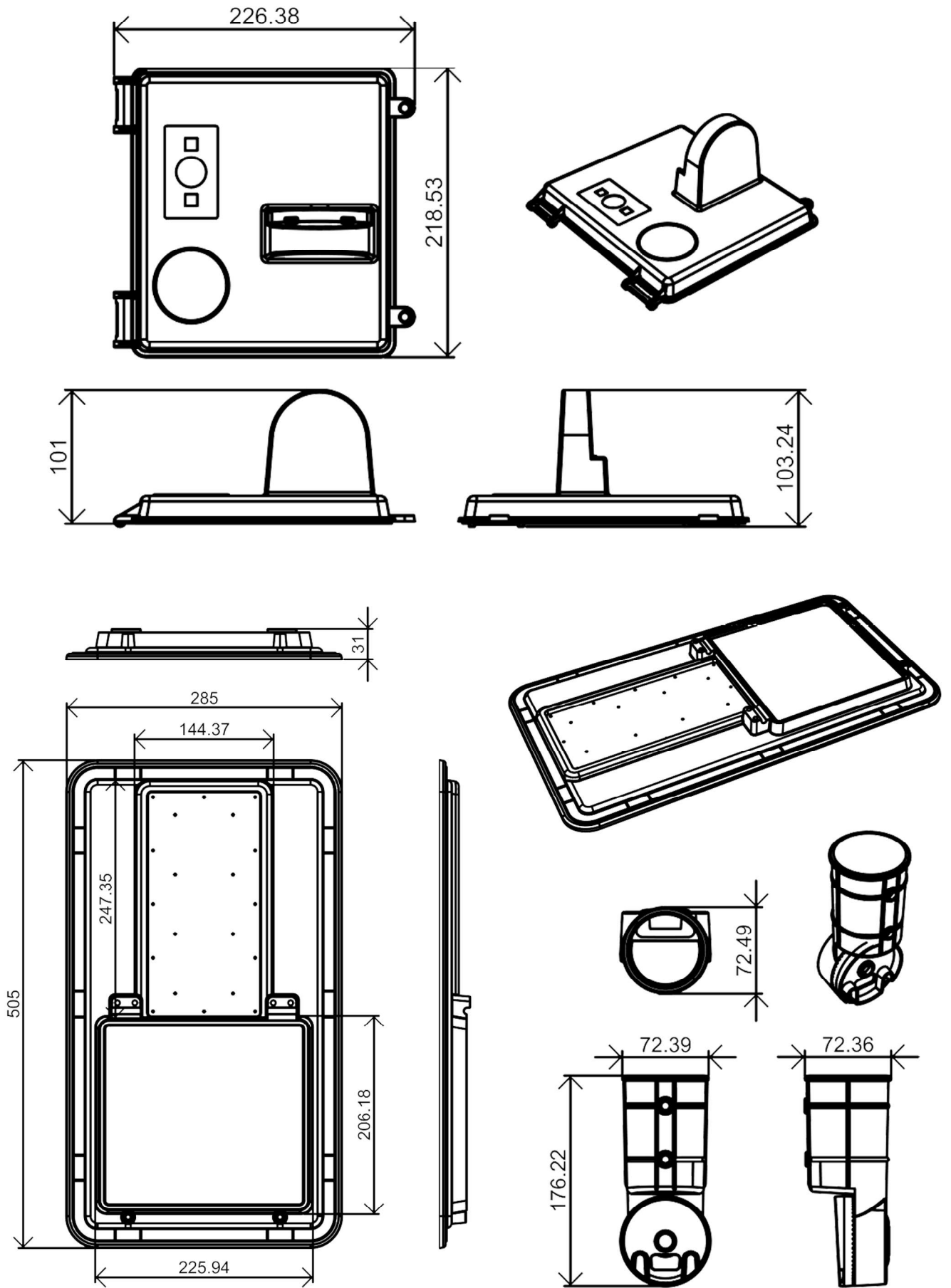

灯体285*505*31mm 重量0.53KG

爆炸图

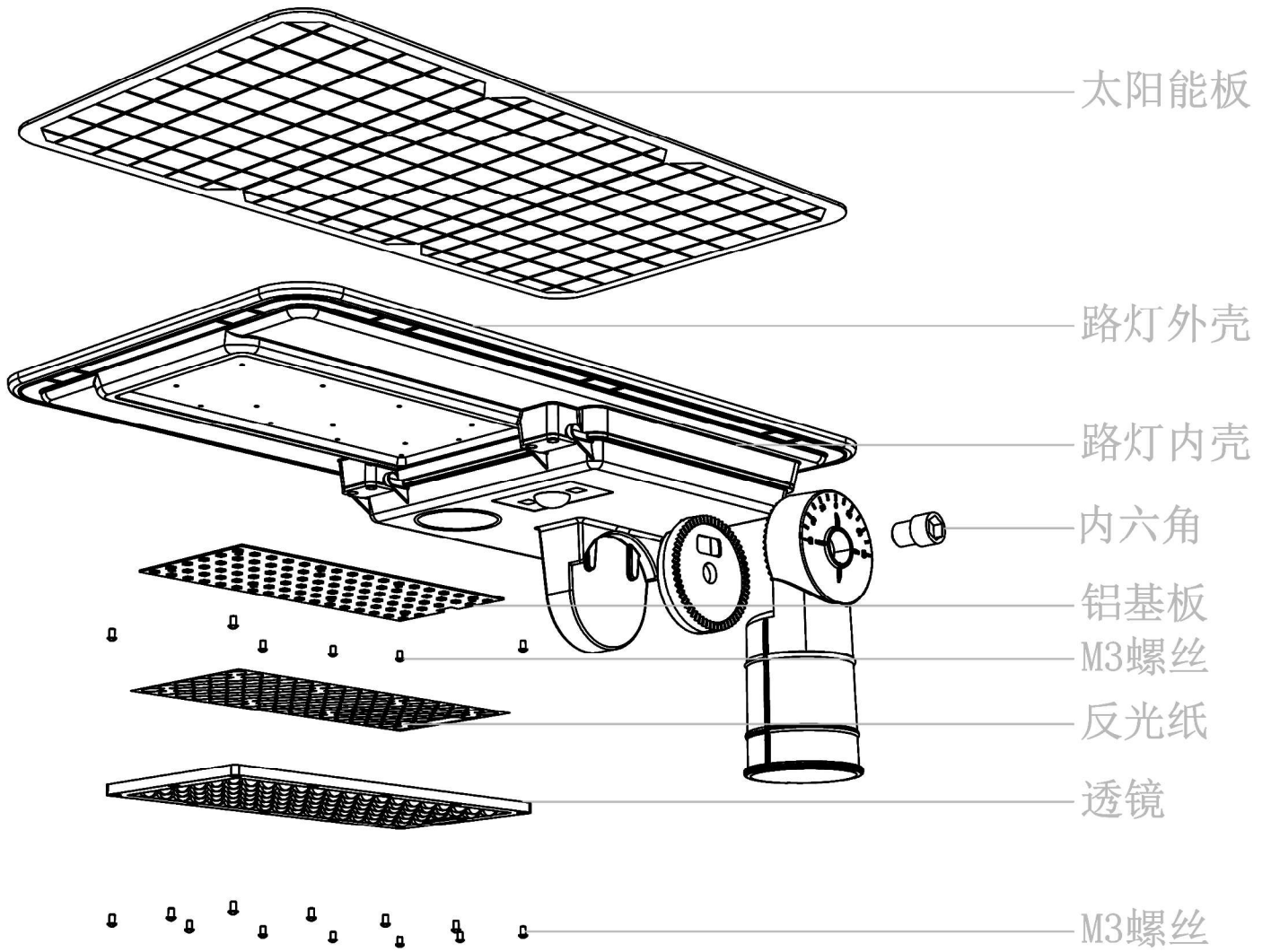

包装尺寸

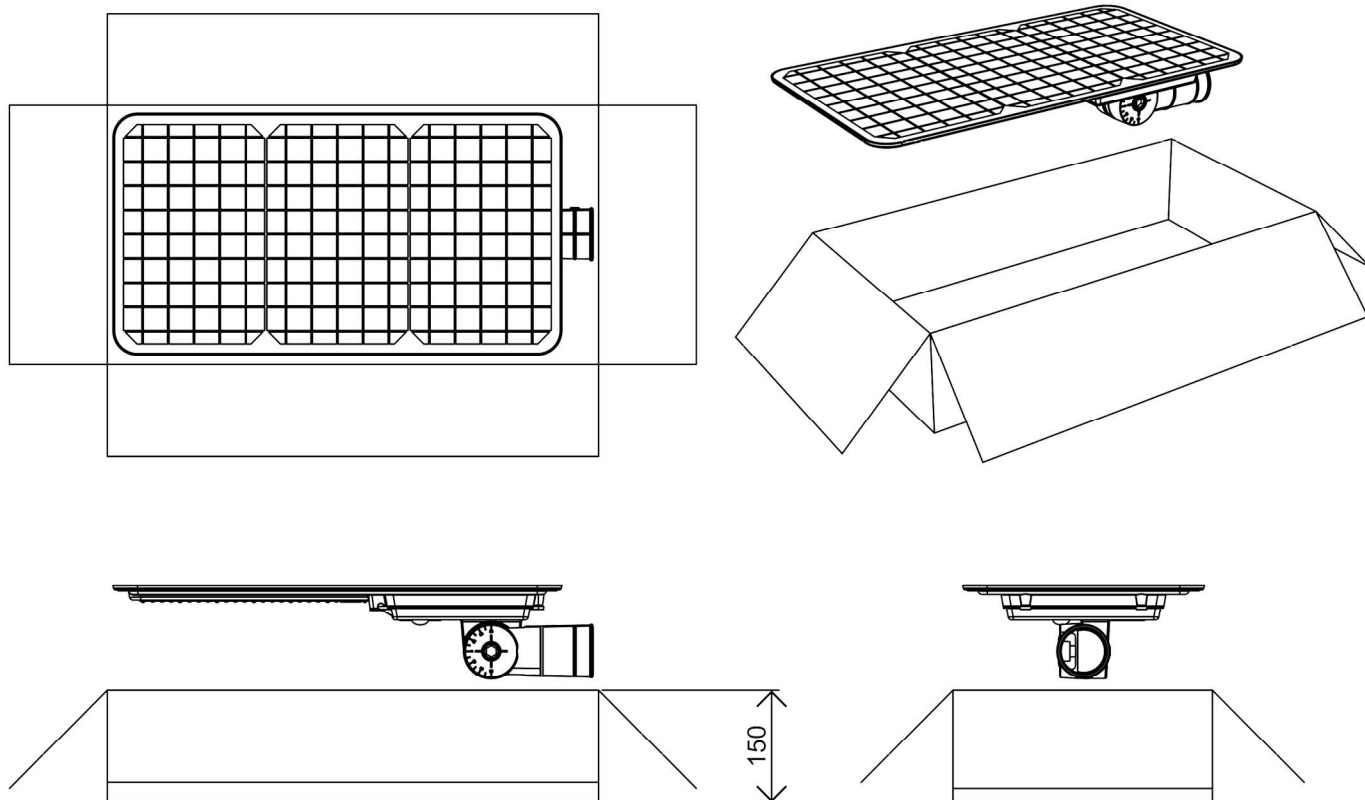

外箱尺寸：510mm*290mm*H150mm

包装总重量：2.7KG